



# INSTALLATION INSTRUCTIONS

## PART NUMBER: RK-3929

This Assembly Fits:

SEE CATALOG FOR CURRENT APPLICATIONS

Congratulations, you have purchased the finest custom air cleaner that money can buy. With proper care, this filter will last 1 million miles or more. This custom air cleaner replaces the stock air cleaner assembly. The following procedure **MUST** be followed to ensure a proper fit and seal of the custom air cleaner.

### PARTS LIST:

Description	Qty.	Part #
A Breather Bolts		OEM Component
B Filter Element	1	E-3040
C Back Plate	1	03102
D Spacer Cushion Assy., LH	1	82919
E Spacer Cushion Assy., RH	1	82920
F Velocity Stack	1	08935
G Breather Bolt Extension	2	82923
H Screw; ¼-20 x ¼ Soc Cap Screw	3	07731
I Bolt; ¼-20 x ½ Button Socket	8	07706
J Spacer; 1.31"L, .375"OD	4	08599-1
K Washer; 1/2" ID, .040" THK	2	08322
L Grommet; .625"OD, .375"ID, .25 THK	1	08090
M Vent; 1/8 Hose, ¼ NPT, Plastic	1	08052
N Plug; Rubber	1	21678
O Plug; 1/4 NPT, Plastic Blk.	1	08032

### Not Shown

Thread Locker	1	482
---------------	---	-----

### Product Available to Purchase Separately

Replacement Element	E-3040
---------------------	--------

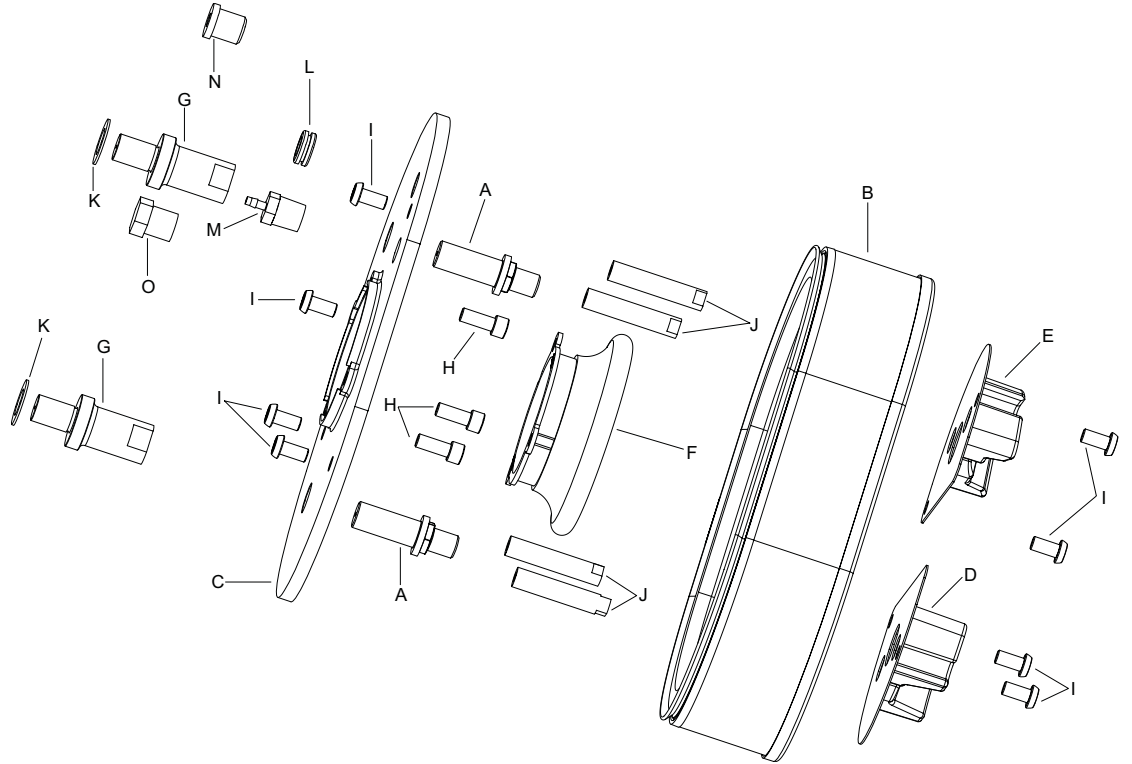

**THESE INSTRUCTIONS MUST BE FOLLOWED EVERY TIME THE FILTER IS SERVICED, OTHERWISE THE FILTER MAY NOT SEAL, AND DAMAGE TO THE ENGINE COULD RESULT.**

### TO START:

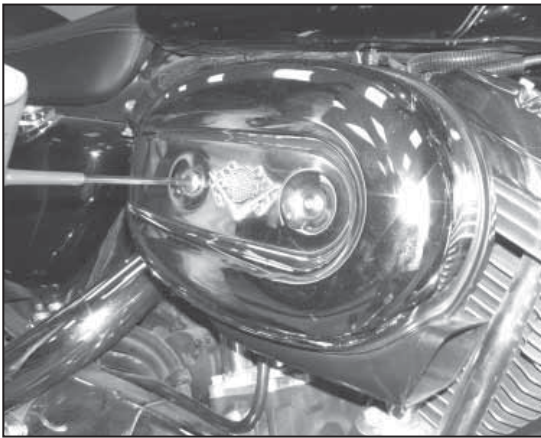

1. Remove the stock air filter cover.

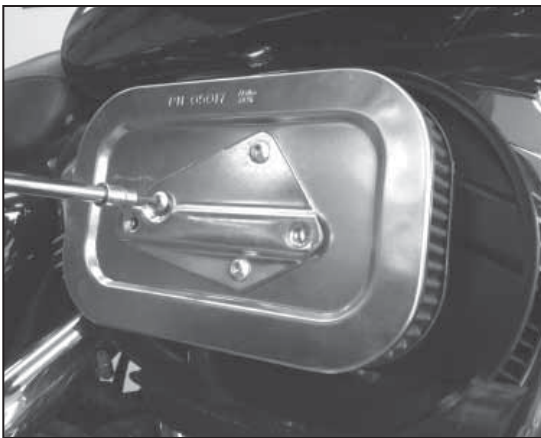

2. Remove the three screws from the air filter bracket and remove the stock air filter.

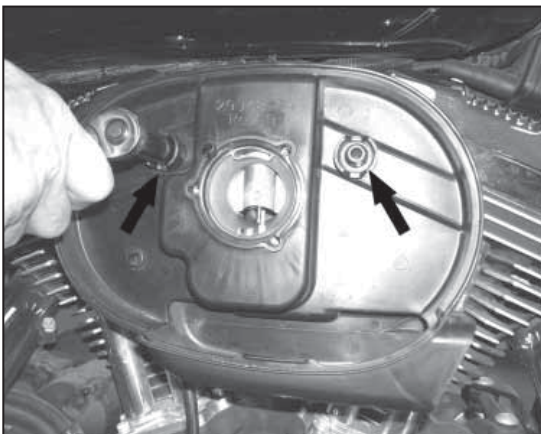

3. Remove the two stock breather bolts.

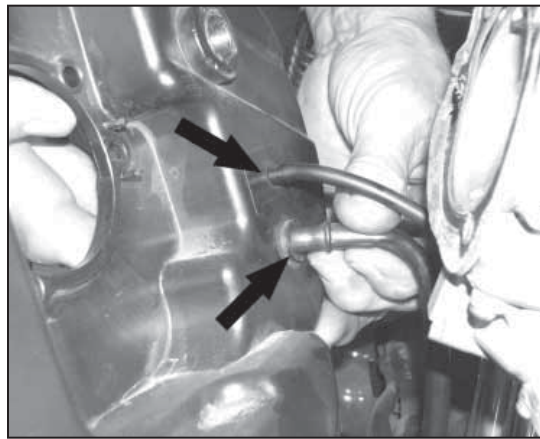

4. On carbureted models unplug the carbon canister vent line and fuel vent line from the back of the airbox.

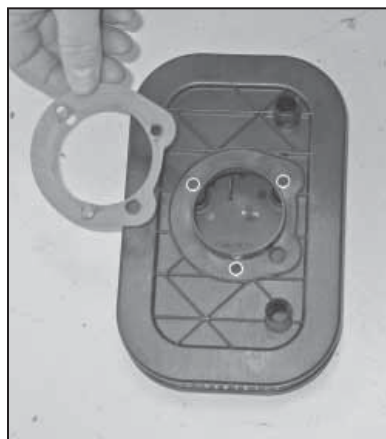

5. Remove the stock air filter gasket from the stock filter.

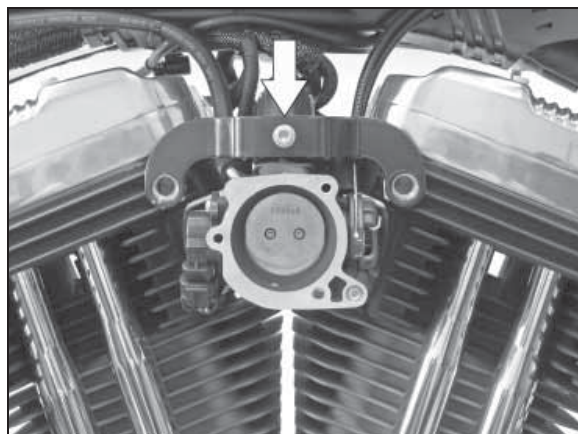

5a. On fuel injected models remove the bolt which secures the throttle body support bracket and then remove the support bracket.  
**NOTE: K&N Engineering, Inc. recommends that customers do not discard the factory air intake components.**

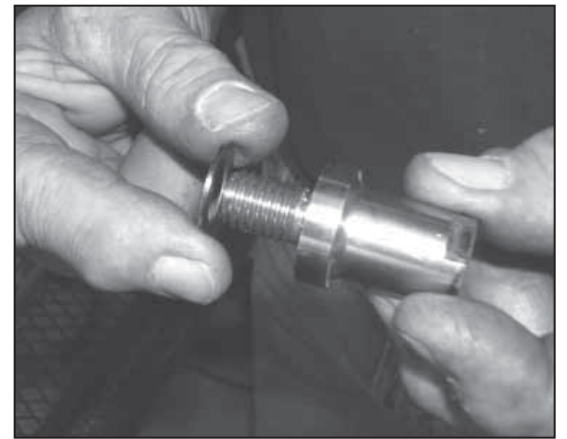

6. On carbureted models, install one of the provided washers onto each of the breather bolt extensions.

**NOTE: On fuel injected models the washers will not be used.**

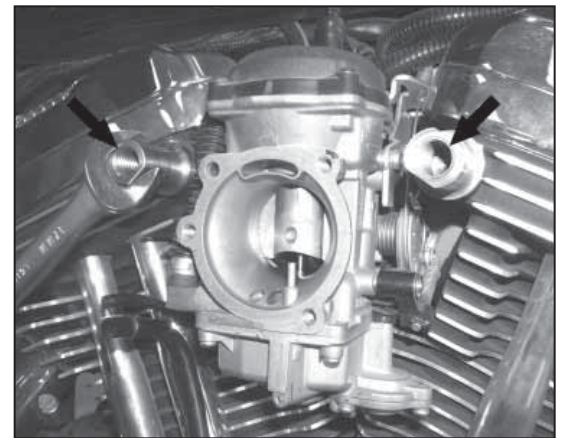

7. Install the breather bolt extensions into the stock breather bolt locations.



8. Install the four bolts from step 8 through the back plate and thread the bolts into the provided spacers.

**NOTE: Apply the provided thread locker to four of the provided button socket bolts.**

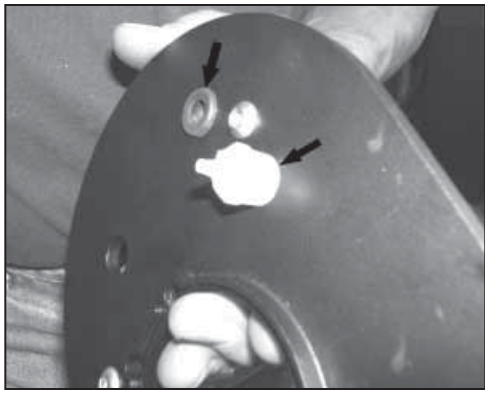

9. For carbureted models install the provided grommet and plastic vent into the back plate (08090 & 08052).

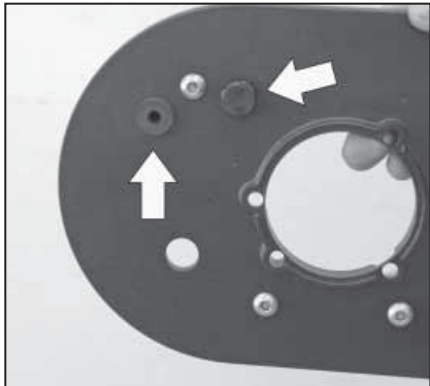

9a. For fuel injected models, install the 1/4" NPT plug and rubber cap plug into the back plate (21678 and 08032).



10. Install the provided velocity stack into the back plate.

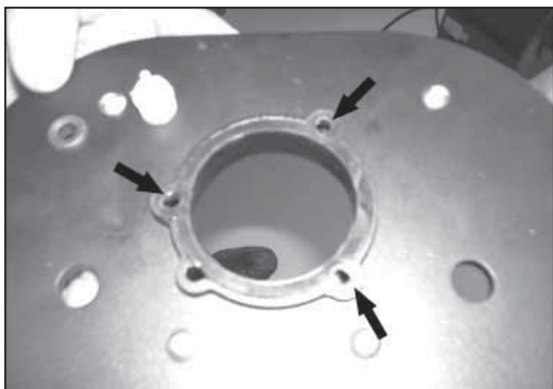

11. Align the holes of the velocity stack with the bolt holes in the back plate.



12. Install the three cap screws (07731) by gently pulling back on the velocity stack.

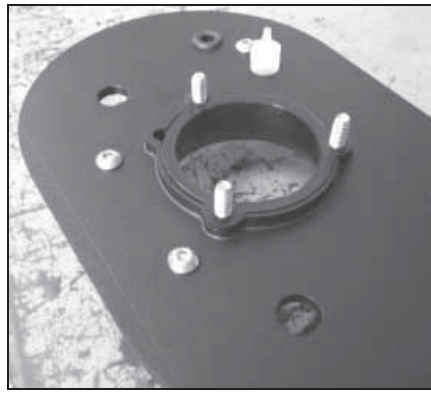

13. Push the cap screws through the tabs on the velocity stack.

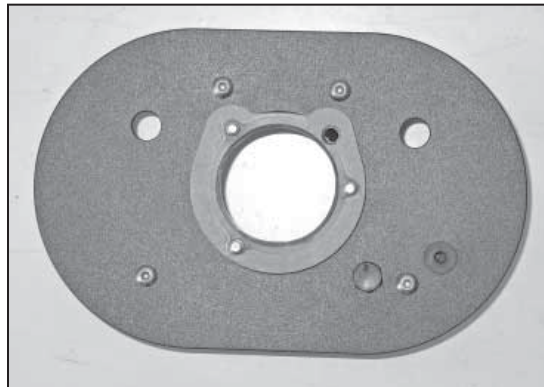

13a. On fuel injected models install the factory gasket onto the K&N back plate.

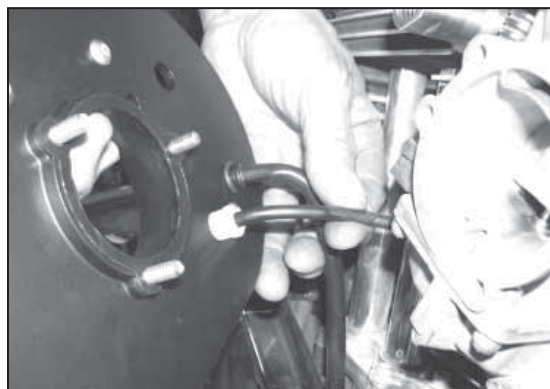

14. On carbureted models, reinstall the fuel vent line and carbon canister line removed in step #4.



15. Install the back plate and thread the stock breather bolts into the breather extensions. Do not tighten at this time.

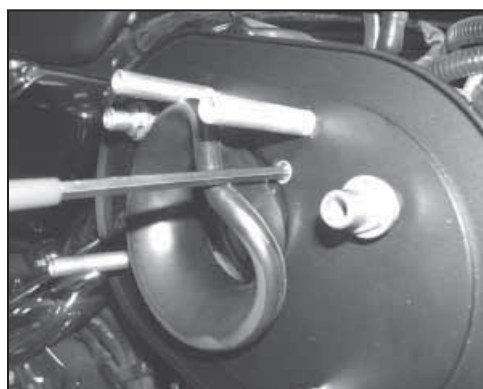

16. Install the three cap screws into the carburetor/throttle body. It is necessary to pull the velocity stack back for access.

17. Recheck the velocity stack to make sure it is completely seated.

18. Tighten the stock breather bolts completely.

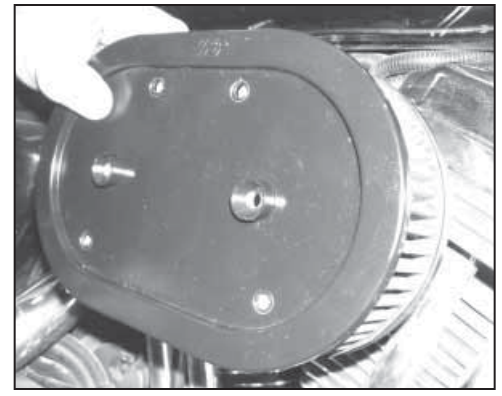

19. Install the K&N air filter onto the back plate.



20. Use the button socket bolts (07706) and install each of the spacer cushion assemblies into the spacers from step 9.

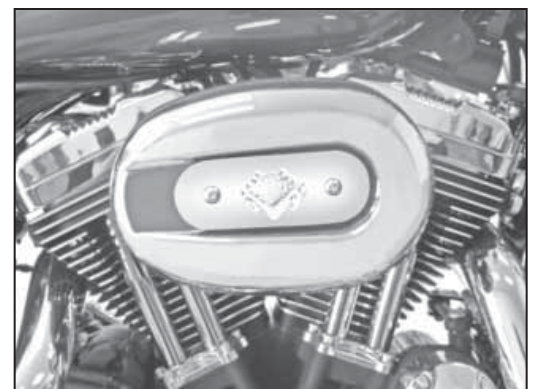

21. Reinstall the stock air filter cover using the stock bolts.

#### ROAD TEST:

1. Start the engine with the transmission in neutral. Listen for air leaks or odd noises. For air leaks secure hoses and connections. For odd noises, find cause and repair before proceeding. This kit will function identically to the factory system except for being louder and much more responsive.

2. Test ride the vehicle. Listen for odd noises or rattles and fix as necessary.

3. If road test is fine, you can now enjoy the added power and performance from your kit.

4. K&N Engineering Inc., suggests checking the air filter element periodically for excessive dirt build-up. When the element becomes covered in dirt (or once a year), service it according to the instructions on the Recharger service kit, part number 99-5050 or 99-5000.